

PSP 100

Electronic Vacuum Switch

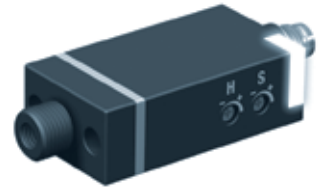

PSP series electronic vacuum switches have integrated threshold and hysteresis adjustment as standard. 3 vacuum fittings (G1/8" Male, M5 female or M5 F Base) and 2 electrical connections (2 meter cable and M8 connector) make up the standard range.

Industry-specific applications

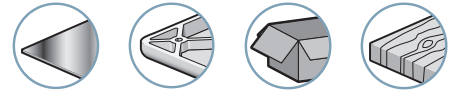

Specifications

Models	PSP 100 L	PSP 100 LM5	PSP 100 C	PSP 100 CM5
Compatible fluids	All non-corrosive, filtered, non-lubricated gases			
Supply	Regulated 18-30 V DC, polarity inversion protection			
Current consumed	< 20 mA			
Transistor output	NO 125 mA with 24 VDC			
Thermal drift	± 3% of the measuring scale between 0 and 50°C / 32 and 122°F			
Output viewing	LED			
Response time	< 5 ms			
Threshold adjustment	By 3/4 turn potentiometer			
Hysteresis adjustment	0 to 30% adjustment by 3/4 turn potentiometer			
EMC	Industrial standard class B			
Materials	PA 66 and brass	PA 66 and Alu.	PA 66 and brass	PA 66 and Alu.
Temperature	Operation: 0 to 50 °C / 32 to 122 °F Storage: -10 to 60 °C / 14 to 140 °F			
Protection	IP 50			
Electrical connection	PVC cable (length 2m)		M8 connector (4 poles)	
Pneumatic connection	G1/8"-M or M5-F	Base M5-F	G1/8"-M or M5-F	Base M5-F
Weight	62 g	67 g	22 g	27 g
Adjustment range	0 to -1 bar			

Advantages

- 1 configurable digital output
- Adjustable hysteresis
- Measuring range: 0 / -1 bar
- Overpressure: +3 bar
- PNP

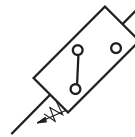

Additional Information

Electrical connections

- PVC cable (length 2m)
 - Brown (+24 V)
 - Blue (0 V)
 - Black (Contact)

■ M8 connector

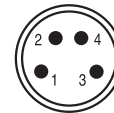

- 1 = + 24 V - Brown
- 2 = -
- 3 = 0 V - Blue
- 4 = Contact - Black

Vacuum switch attachment - Clip Part No: PSE.F

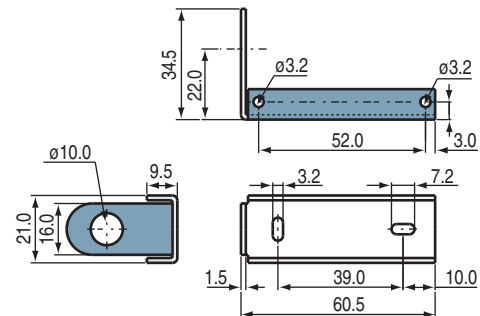

Dimensions

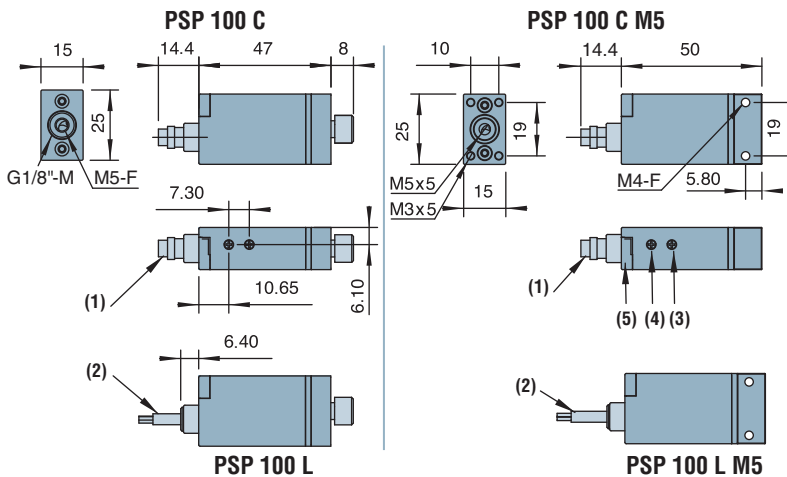

- (1) M8 4 pole connector version
- (2) PVC cable version (2 m)
- (3) Hysteresis adjustment
- (4) Threshold adjustment
- (5) Threshold display LED

Note: all dimensions shown in (mm)

Accessories

- Straight or angled connector, see page 11/12.
- Mounting on vacuum pump:
 - GVP series: GVO PSP 100 C
 - GVO PSP 100 L
 - GEMP series: VB option



For all orders, please specify:
Model + Electrical connection + Vacuum connection.
Example: PSP100C

1: Model	2: Electrical connection	3: Vacuum connection
PSP 100	L 2 m cable C M8 connector	- G1/8"-M or M5-F M5 Base M5-F

PSP 100 ANA

Electronic Vacuum Switch Analog Output

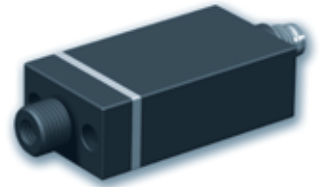

The PSP 100 ANA contains an analog output. It is fitted with 2 vacuum connections as standard (G1/8" male or M5 Female) and one M8 electrical connector.

Industry-specific applications

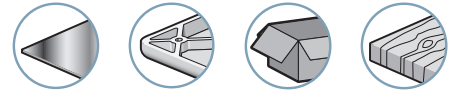

Specifications

Compatible fluids	All filtered, non-corrosive, non-lubricated gases
Supply	24 V DC (18 V DC min / 30 V DC max)
Current draw	< 20 mA
Analog output	1 to 5 VDC from 0 to -1 bar
Thermal drift	± 3% of the measuring scale between 0 and 50°C
Response time	< 5 ms
EMC	Industrial standard Class B
Materials	PA 66 and brass
Temperature	Operation: 0 to 50 °C / 32 to 122 °F Storage: -10 to 60 °C / 14 to 140 °F
Protection	IP 50
Electrical connection	M8 connector (4 pins)
Pneumatic connection	G1/8" Male and M5 Female
Weight	22 g

Advantages

- 1 analog output from 1 to 5 VDC
- Measuring range: 0 / -1 bar
- Overpressure: +3 bar max.
- PNP

Electrical connections

- M8 connector

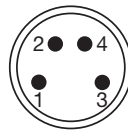

- 1 = + 24 V (Brown)
- 2 = analog output from 1 to 5 VDC (white)
- 3 = 0 V common (blue)
- 4 = -

Dimensions

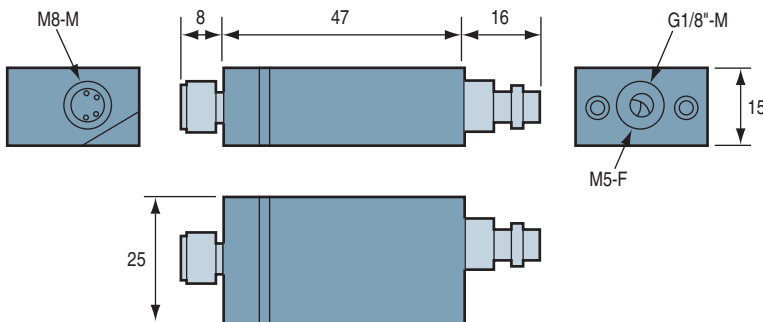

Note: all dimensions shown in (mm)

Accessories

- Straight or elbow connector, see page 11/12.



For all orders, please specify: PSP 100 ANA